

FLOOR-STANDING TYPE AIR CONDITIONER

Owner's Manual & Installation Manual

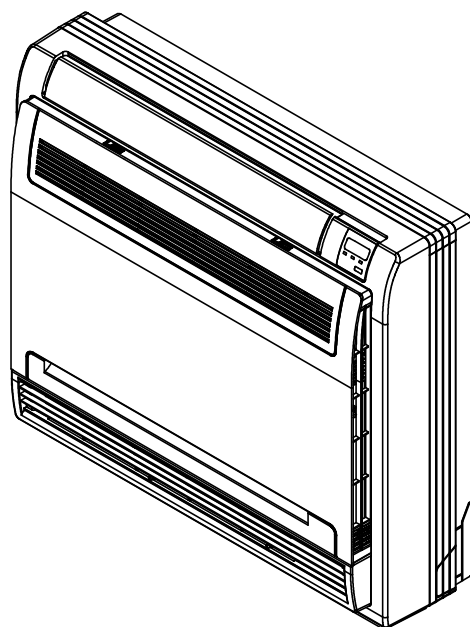

IMPORTANT NOTE:

Read this manual carefully before installing or operating your new air conditioning unit. Make sure to save this manual for future reference.

Please check the applicable models, technical data, F-GAS(if any) and manufacturer information from the "Owner's Manual - Product Fiche " in the packaging of the outdoor unit.
(European Union products only)

Table of Contents

| | |
|---------------------------------|-----------|
| Safety Precautions | 04 |
|---------------------------------|-----------|

Owner's Manual

| | |
|--|-----------|
| Unit Specifications and Features..... | 09 |
|--|-----------|

| | |
|-----------------------------|----|
| 1. Indoor unit display..... | 09 |
|-----------------------------|----|

| | |
|-------------------------------|----|
| 2. Operating temperature..... | 10 |
|-------------------------------|----|

| | |
|-------------------------|----|
| 3. Other features | 11 |
|-------------------------|----|

| | |
|--------------------------------------|----|
| 4. Adjusting Air Flow Direction..... | 12 |
|--------------------------------------|----|

| | |
|----------------------------------|-----------|
| Care and Maintenance..... | 13 |
|----------------------------------|-----------|

| | |
|-----------------------------|-----------|
| Troubleshooting..... | 15 |
|-----------------------------|-----------|

Installation Manual

| | |
|---|-----------|
| Accessories..... | 18 |
| Installation Summary..... | 19 |
| Unit Parts..... | 20 |
| Indoor Unit Installation..... | 21 |
| 1. Select installation location..... | 21 |
| 2. Hang indoor unit..... | 23 |
| 3. Drill wall hole for connective piping..... | 24 |
| 4. Connect drain hose..... | 25 |
| Outdoor Unit Installation..... | 26 |
| 1. Select installation location..... | 26 |
| 2. Install drain joint..... | 27 |
| 3. Anchor outdoor unit..... | 27 |
| Refrigerant Piping Connection..... | 29 |
| A. Note on Pipe Length..... | 29 |
| B. Connection Instructions –Refrigerant Piping..... | 31 |
| 1. Cut pipe..... | 31 |
| 2. Remove burrs..... | 31 |
| 3. Flare pipe ends..... | 31 |
| 4. Connect pipes..... | 32 |
| Wiring..... | 33 |
| 1. Outdoor Unit Wiring..... | 33 |
| 2. Indoor Unit Wiring..... | 35 |
| 3. Power Specifications..... | 35 |
| Air Evacuation..... | 36 |
| 1. Evacuation Instructions..... | 36 |
| 2. Note on Adding Refrigerant..... | 37 |
| Test Run..... | 38 |

Safety Precautions

Read Safety Precautions Before Operation and Installation

Incorrect installation due to ignoring instructions can cause serious damage or injury. The seriousness of potential damage or injuries is classified as either a **WARNING** or **CAUTION**.



WARNING

This symbol indicates the possibility of personnel injury or loss of life.



CAUTION

This symbol indicates the possibility of property damage or serious consequences.



WARNING

This appliance can be used by children aged from 8 years and above and persons with reduced physical, sensory or mental capabilities or lack of experience and knowledge if they have been given supervision or instruction concerning use of the appliance in a safe way and understand the hazards involved. Children shall not play with the appliance. Cleaning and user maintenance shall not be made by children without supervision(EN Standard requirements).

This appliance is not intended for use by persons(including children) with reduced physical, sensory or mental capabilities, or lack of experience and knowledge, unless they have been given supervision or instruction concerning use of the appliance by a person responsible for their safety. Children should be supervised to ensure that they do not play with the appliance(IEC Standard requirements).



WARNINGS FOR PRODUCT USE

- If an abnormal situation arises (like a burning smell), immediately turn off the unit and disconnect the power. Call your dealer for instructions to avoid electric shock, fire or injury.
- **Do not** insert fingers, rods or other objects into the air inlet or outlet. This may cause injury, since the fan may be rotating at high speeds.
- **Do not** use flammable sprays such as hair spray, lacquer or paint near the unit. This may cause fire or combustion.
- **Do not** operate the air conditioner in places near or around combustible gases. Emitted gas may collect around the unit and cause explosion.
- **Do not** operate your air conditioner in a wet room such as a bathroom or laundry room. Too much exposure to water can cause electrical components to short circuit.
- **Do not** expose your body directly to cool air for a prolonged period of time.
- **Do not** allow children to play with the air conditioner. Children must be supervised around the unit at all times.
- If the air conditioner is used together with burners or other heating devices, thoroughly ventilate the room to avoid oxygen deficiency.
- In certain functional environments, such as kitchens, server rooms, etc., the use of specially designed air-conditioning units is highly recommended.

CLEANING AND MAINTENANCE WARNINGS

- Turn off the device and disconnect the power before cleaning. Failure to do so can cause electrical shock.
- **Do not** clean the air conditioner with excessive amounts of water.
- **Do not** clean the air conditioner with combustible cleaning agents. Combustible cleaning agents can cause fire or deformation.



CAUTION

- Turn off the air conditioner and disconnect the power if you are not going to use it for a long time.
- Turn off and unplug the unit during storms.
- Make sure that water condensation can drain unhindered from the unit.
- **Do not** operate the air conditioner with wet hands. This may cause electric shock.
- **Do not** use device for any other purpose than its intended use.
- **Do not** climb onto or place objects on top of the outdoor unit.
- **Do not** allow the air conditioner to operate for long periods of time with doors or windows open, or if the humidity is very high.



ELECTRICAL WARNINGS

- Only use the specified power cord. If the power cord is damaged, it must be replaced by the manufacturer, its service agent or similarly qualified persons in order to avoid a hazard.
- Keep power plug clean. Remove any dust or grime that accumulates on or around the plug. Dirty plugs can cause fire or electric shock.
- **Do not** pull power cord to unplug unit. Hold the plug firmly and pull it from the outlet. Pulling directly on the cord can damage it, which can lead to fire or electric shock.
- **Do not** modify the length of the power supply cord or use an extension cord to power the unit.
- **Do not** share the electrical outlet with other appliances. Improper or insufficient power supply can cause fire or electrical shock.
- The product must be properly grounded at the time of installation, or electrical shock may occur.
- For all electrical work, follow all local and national wiring standards, regulations, and the Installation Manual. Connect cables tightly, and clamp them securely to prevent external forces from damaging the terminal. Improper electrical connections can overheat and cause fire, and may also cause shock. All electrical connections must be made according to the Electrical Connection Diagram located on the panels of the indoor and outdoor units.
- All wiring must be properly arranged to ensure that the control board cover can close properly. If the control board cover is not closed properly, it can lead to corrosion and cause the connection points on the terminal to heat up, catch fire, or cause electrical shock.
- If connecting power to fixed wiring, an all-pole disconnection device which has at least 3mm clearances in all poles, and have a leakage current that may exceed 10mA, the residual current device(RCD) having a rated residual operating current not exceeding 30mA, and disconnection must be incorporated in the fixed wiring in accordance with the wiring rules.

TAKE NOTE OF FUSE SPECIFICATIONS

The air conditioner's circuit board (PCB) is designed with a fuse to provide overcurrent protection. The specifications of the fuse are printed on the circuit board ,such as :

Indoor unit: T3.15A/250VAC, T5A/250VAC, T10A/250VAC, etc.

Outdoor unit: T20A/250VAC(≤ 18000 Btu/h units), T30A/250VAC(> 18000 Btu/h units)

NOTE: For the units with R32 or R290 refrigerant , only the blast-proof ceramic fuse can be used.



WARNINGS FOR PRODUCT INSTALLATION

1. Installation must be performed by an authorized dealer or specialist. Defective installation can cause water leakage, electrical shock, or fire.
2. Installation must be performed according to the installation instructions. Improper installation can cause water leakage, electrical shock, or fire.
(In North America, installation must be performed in accordance with the requirement of NEC and CEC by authorized personnel only.)
3. Contact an authorized service technician for repair or maintenance of this unit. This appliance shall be installed in accordance with national wiring regulations.
4. Only use the included accessories, parts, and specified parts for installation. Using non-standard parts can cause water leakage, electrical shock, fire, and can cause the unit to fail.
5. Install the unit in a firm location that can support the unit's weight. If the chosen location cannot support the unit's weight, or the installation is not done properly, the unit may drop and cause serious injury and damage.
6. Install drainage piping according to the instructions in this manual. Improper drainage may cause water damage to your home and property.
7. For units that have an auxiliary electric heater, **do not** install the unit within 1 meter (3 feet) of any combustible materials.
8. **Do not** install the unit in a location that may be exposed to combustible gas leaks. If combustible gas accumulates around the unit, it may cause fire.
9. Do not turn on the power until all work has been completed.
10. When moving or relocating the air conditioner, consult experienced service technicians for disconnection and reinstallation of the unit.
11. How to install the appliance to its support, please read the information for details in "indoor unit installation" and "outdoor unit installation" sections .

Note about Fluorinated Gasses(Not applicable to the unit using R290 Refrigerant)

1. This air-conditioning unit contains fluorinated greenhouse gasses. For specific information on the type of gas and the amount, please refer to the relevant label on the unit itself or the "Owner's Manual - Product Fiche " in the packaging of the outdoor unit. (European Union products only).
2. Installation, service, maintenance and repair of this unit must be performed by a certified technician.
3. Product uninstallation and recycling must be performed by a certified technician.
4. For equipment that contains fluorinated greenhouse gases in quantities of 5 tonnes of CO₂ equivalent or more, but of less than 50 tonnes of CO₂ equivalent, If the system has a leak-detection system installed, it must be checked for leaks at least every 24 months.
5. When the unit is checked for leaks, proper record-keeping of all checks is strongly recommended.

**WARNING for Using R32/R290 Refrigerant**

- When flammable refrigerant are employed, appliance shall be stored in a well-ventilated area where the room size corresponds to the room area as specific for operation.

For R32 frigerant models:

Appliance shall be installed, operated and stored in a room with a floor area larger than X m².

Appliance shall not be installed in an unventilated space, if that space is smaller than X m²

(Please see the following form).

| Model (Btu/h) | Minimum room area (m ²) |
|------------------|--|
| ≤18000 | 18 |

- Reusable mechanical connectors and flared joints are not allowed indoors. (**EN** Standard Requirements).
- Mechanical connectors used indoors shall have a rate of not more than 3g/year at 25% of the maximum allowable pressure. When mechanical connectors are reused indoors, sealing parts shall be renewed. When flared joints are reused indoors, the flare part shall be re-fabricated. (**UL** Standard Requirements)
- When mechanical connectors are reused indoors, sealing parts shall be renewed. When flared joints are reused indoors, the flare part shall be re-fabricated. (**IEC** Standard Requirements)

European Disposal Guidelines

This marking shown on the product or its literature, indicates that waste electrical and electronic equipment should not be mixed with general household waste.

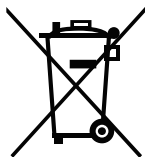

Correct Disposal of This Product (Waste Electrical & Electronic Equipment)

This appliance contains refrigerant and other potentially hazardous materials. When disposing of this appliance, the law requires special collection and treatment. **Do not** dispose of this product as household waste or unsorted municipal waste.

When disposing of this appliance, you have the following options:

- Dispose of the appliance at designated municipal electronic waste collection facility.
- When buying a new appliance, the retailer will take back the old appliance free of charge.
- The manufacturer will take back the old appliance free of charge.
- Sell the appliance to certified scrap metal dealers.

Special notice

Disposing of this appliance in the forest or other natural surroundings endangers your health and is bad for the environment. Hazardous substances may leak into the ground water and enter the food chain.

Unit Specifications and Features

Indoor unit display

NOTE: This display panel on the indoor unit can be used to operate the unit in case the remote control has been misplaced or is out of batteries.

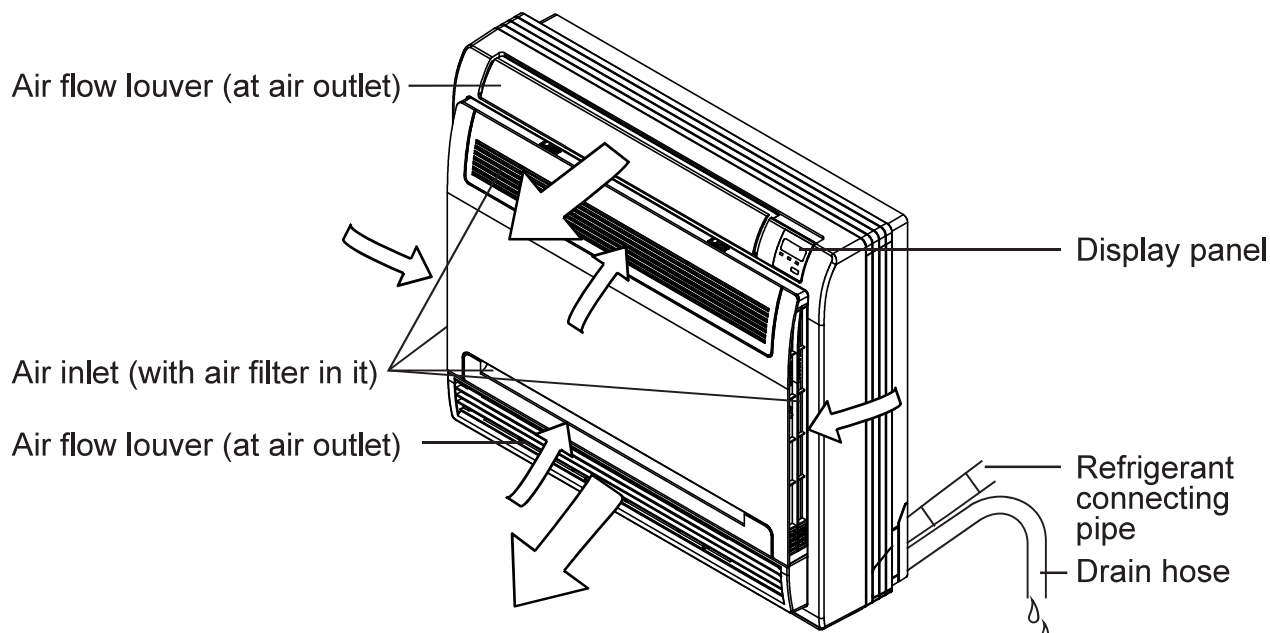

Display panel

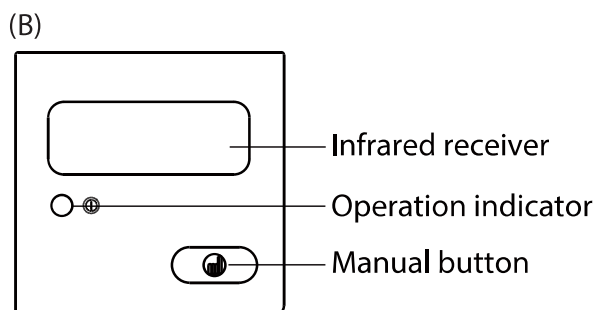
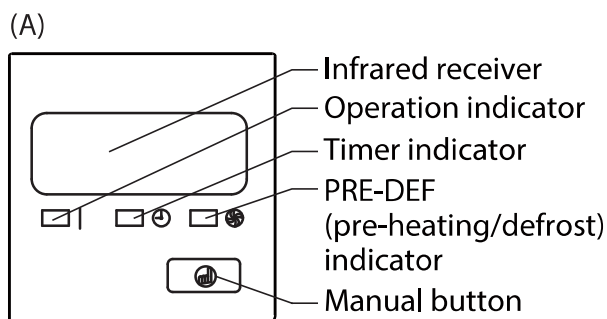

- **88** Displays temperature and Error codes:
- " **df** " when defrosting (for model B cooling & heating units)
- " **0m** " for 3 seconds when:
 - TIMER ON is set (for model B)
 - SWING or SILENCE is turned on
- " **0f** " for 3 seconds when:
 - TIMER OFF is set (for model B)
 - SWING or SILENCE is turned off
- " **Sc** " when unit is self-cleaning
- " **Fp** " when 8 C heating feature is turned on

MANUAL button: This button selects the mode in the following order: AUTO, FORCED COOL, OFF.

FORCED COOL mode: In FORCED COOL mode, the Operation light flashes. The system will then turn to AUTO after it has cooled with a high wind speed for 30 minutes. The remote control will be disabled during this operation.

OFF mode: When the panel is turned OFF, the unit turns off and the remote control is re-enabled.

Operating temperature

When your air conditioner is used outside of the following temperature ranges, certain safety protection features may activate and cause the unit to disable.

Inverter Split Type

| | COOL mode | HEAT mode | DRY mode |
|---------------------|---|------------------------------|---|
| Room Temperature | 17°C - 32°C (62°F - 90°F) | 0°C - 30°C (32°F - 86°F) | 10°C - 32°C (50°F - 90°F) |
| Outdoor Temperature | 0°C - 50°C (32°F - 122°F) | -15°C - 24°C (5°F - 75°F) | 0°C - 50°C (32°F - 122°F) |
| | -15°C - 50°C (5°F - 122°F) (For models with low temp. cooling systems.) | | |
| | 0°C - 52°C (32°F - 126°F) (For special tropical models) | | 0°C - 52°C (32°F - 126°F) (For special tropical models) |

FOR OUTDOOR UNITS WITH AUXILIARY ELECTRIC HEATER

When outside temperature is below 0°C (32°F), we strongly recommend keeping the unit plugged in at all time to ensure smooth ongoing performance.

Fixed-speed Type

| | COOL mode | HEAT mode | DRY mode |
|---------------------|--|-----------------------|---|
| Room Temperature | 17°C-32°C (62°F-90°F) | 0°C-30°C (32°F-86°F) | 10°C-32°C (50°F-90°F) |
| Outdoor Temperature | 18°C-43°C (64°F-109°F) | -7°C-24°C (19°F-75°F) | 11°C-43°C (52°F-109°F) |
| | -7°C-43°C (19°F-109°F) (For models with low-temp cooling systems) | | 18°C-43°C (64°F-109°F) |
| | 18°C-52°C (64°F-126°F) (For special tropical models) | | 18°C-52°C (64°F-126°F) (For special tropical models) |

NOTE: Room relative humidity less than 80%. If the air conditioner operates in excess of this figure, the surface of the air conditioner may attract condensation. Please sets the vertical air flow louver to its maximum angle (vertically to the floor), and set HIGH fan mode.

To further optimize the performance of your unit, do the following:

- Keep doors and windows closed.
- Limit energy usage by using TIMER ON and TIMER OFF functions.
- Do not block air inlets or outlets.
- Regularly inspect and clean air filters.

Other features

Default Setting (some models)

When the air conditioner restarts after a power failure, it will default to the factory settings (AUTO mode, AUTO fan, 24°C (76°F)). This may cause inconsistencies on the remote control and unit panel. Use your remote control to update the status.

Auto-Restart (some models)

In case of power failure, the system will immediately stop. When power returns, the Operation light on the indoor unit will flash. To restart the unit, press the **ON/OFF** button on the remote control. If the system has an auto restart function, the unit will restart using the same settings.

When the outdoor temperature is below zero, the electric heating belt of the outdoor unit chassis is used for ice melting, without defrosting. (some models)

Louver Angle Memory Function (some models)

Some models are designed with a louver angle memory function. When the unit restarts after a power failure, the angle of the horizontal louvers will automatically return to the previous position. The angle of the horizontal louver should not be set too small as condensation may form and drip into the machine. To reset the louver, press the manual button, which will reset the horizontal louver settings.

Refrigerant Leak Detection System (some models)

In the event of a refrigerant leak, the LCD screen will display "EC" and the LED indicator light will flash.

Adjusting Air Flow Direction

- **Manual Swing:** Press Air Direction to fix the louver at a desired angle. The louver swings (upward or downward) at a different angle with each press of the button.

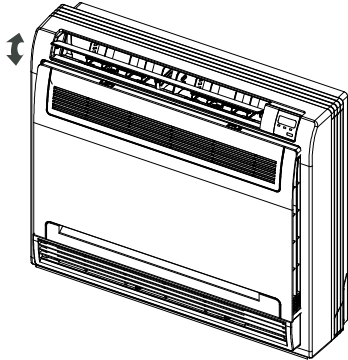

- **When cooling**
Adjust the louver downwards (horizontally).

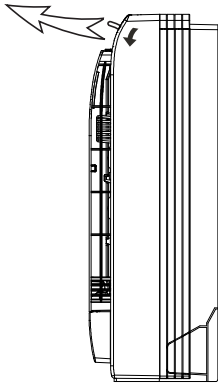

- **When heating**
Adjust the louver vertically.

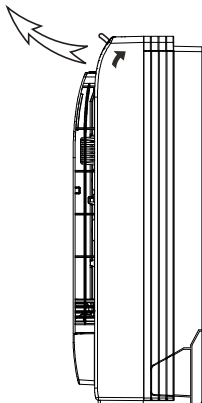

- **Adjust the Air Flow Direction Left and Right**
Hold the knob and move the louver. You will find a knob on the left-side and the right-side blades.

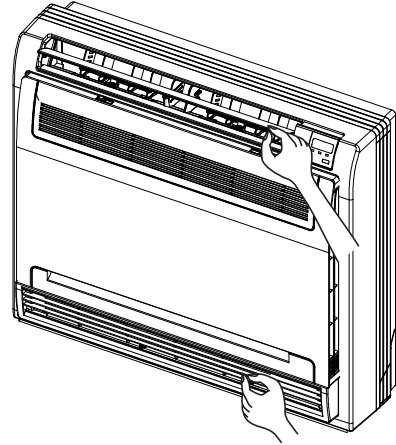

CAUTIONS

Do not try to adjust the horizontal louver by hand. This may cause damage the mechanism and result in condensation forming on the air outlets.

Care and Maintenance

Cleaning Your Indoor Unit



BEFORE CLEANING OR MAINTENANCE

ALWAYS TURN OFF YOUR AIR CONDITIONER SYSTEM AND DISCONNECT ITS POWER SUPPLY BEFORE CLEANING OR MAINTENANCE.



CAUTION

Only use a soft, dry cloth to wipe the unit clean. If the unit is especially dirty, you can use a cloth soaked in warm water to wipe it clean.

- **Do not** use chemicals or chemically treated cloths to clean the unit
- **Do not** use benzene, paint thinner, polishing powder or other solvents to clean the unit. They can cause the plastic surface to crack or deform.
- **Do not** use water hotter than 40°C (104°F) to clean the front panel. This can cause the panel to deform or become discolored.

Cleaning Your Air Filter

A clogged air conditioner can reduce the cooling efficiency of your unit, and can also be bad for your health. Make sure to clean the filter once every two weeks.



WARNING: DO NOT REMOVE OR CLEAN THE FILTER BY YOURSELF

Removing and cleaning the filter can be dangerous. Removal and maintenance must be performed by a certified technician.

1. Open the front panel.
2. Remove the air filter.
Press the claws on the right and left sides of the air filter down slightly, then pull upward.
3. Hold the tabs of the frame, and remove the 4 claws. (The special function filter can be washed with water once every 6 months. It is recommended that you replace it once every 3 years.)

4. Clean the air filter by vacuuming the surface or washing it in warm water with mild detergent.
5. Rinse the filter with clean water and allow it to air-dry. **DO NOT** let the filter dry in direct sunlight.
6. Reinstall the filter.

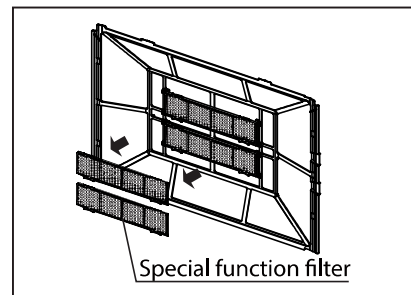
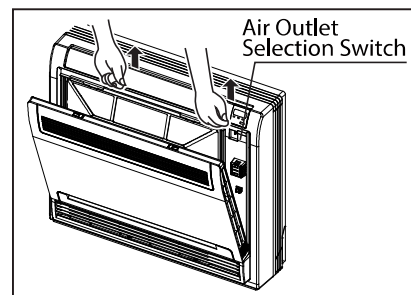
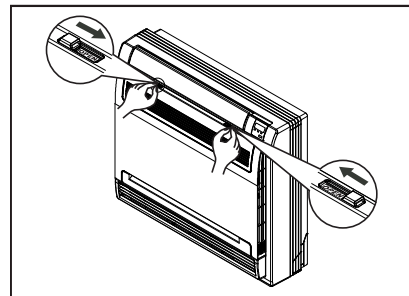

If using water, the inlet side should face down and away from the water stream.



If using a vacuum cleaner, the inlet side should face the vacuum.

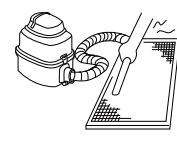



CAUTION

- Before changing the filter or cleaning, turn off the unit and disconnect its power supply.
- When removing filter, do not touch metal parts in the unit. The sharp metal edges can cut you.
- Do not use water to clean the inside of the indoor unit. This can destroy insulation and cause electrical shock.
- Do not expose filter to direct sunlight when drying. This can shrink the filter.



CAUTION

- Any maintenance and cleaning of outdoor unit should be performed by an authorized dealer or a licensed service provider.
- Any unit repairs should be performed by an authorized dealer or a licensed service provider.

Maintenance – Long Periods of Non-Use

If you plan not to use your air conditioner for an extended period of time, do the following:

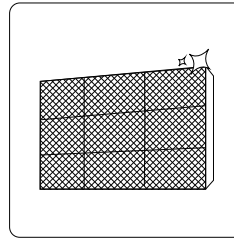

Clean all filters

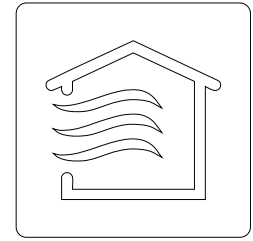

Turn on FAN function until unit dries out completely

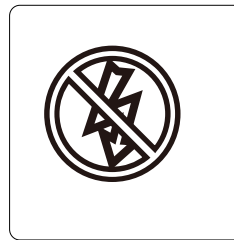

Turn off the unit and disconnect the power

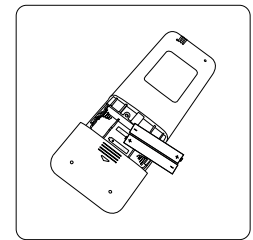

Remove batteries from remote control

Maintenance – Pre-Season Inspection

After long periods of non-use, or before periods of frequent use, do the following:

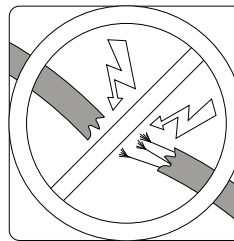

Check for damaged wires

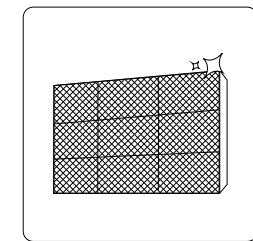

Clean all filters



Check for leaks

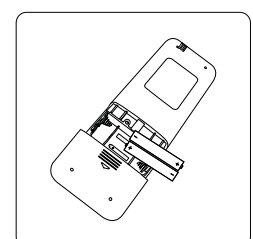

Replace batteries

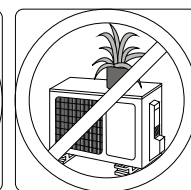
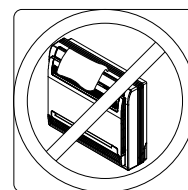

Make sure nothing is blocking all air inlets and outlets

Troubleshooting

SAFETY PRECAUTIONS

If any of the following conditions occurs, turn off your unit immediately!

- The power cord is damaged or abnormally warm
- You smell a burning odor
- The unit emits loud or abnormal sounds
- A power fuse blows or the circuit breaker frequently trips
- Water or other objects fall into or out of the unit

DO NOT ATTEMPT TO FIX THESE YOURSELF! CONTACT AN AUTHORIZED SERVICE PROVIDER IMMEDIATELY!

Common Issues

The following problems are not a malfunction and in most situations will not require repairs.

| Issue | Possible Causes |
|--|--|
| Unit does not turn on when pressing ON/OFF button | The Unit has a 3-minute protection feature that prevents the unit from overloading. The unit cannot be restarted within three minutes of being turned off. |
| | Cooling and Heating Models: If the Operation light and PRE-DEF (Pre-heating/Defrost) indicators are lit up, or the Operation light is lit up and the LCD screen display "dF", the outdoor temperature is too cold and the unit's anti-cold wind is activated in order to defrost the unit. |
| The unit changes from COOL mode to FAN mode | The unit may change its setting to prevent frost from forming on the unit. Once the temperature increases, the unit will start operating in the previously selected mode again. |
| | The set temperature has been reached, at which point the unit turns off the compressor. The unit will continue operating when the temperature fluctuates again. |
| The indoor unit emits white mist | In humid regions, a large temperature difference between the room's air and the conditioned air can cause white mist. |
| Both the indoor and outdoor units emit white mist | When the unit restarts in HEAT mode after defrosting, white mist may be emitted due to moisture generated from the defrosting process. |
| The indoor unit makes noises | A squeaking sound is heard when the system is OFF or in COOL mode. The noise is also heard when the drain pump (optional) is in operation. |
| | A squeaking sound may occur after running the unit in HEAT mode due to expansion and contraction of the unit's plastic parts. |
| Both the indoor unit and outdoor unit make noises | Low hissing sound during operation: This is normal and is caused by refrigerant gas flowing through both indoor and outdoor units. |
| | Low hissing sound when the system starts, has just stopped running, or is defrosting: This noise is normal and is caused by the refrigerant gas stopping or changing direction. |
| | Squeaking sound: Normal expansion and contraction of plastic and metal parts caused by temperature changes during operation can cause squeaking noises. |

| Issue | Possible Causes |
|--|--|
| The outdoor unit makes noises | The unit will make different sounds based on its current operating mode. |
| Dust is emitted from either the indoor or outdoor unit | The unit may accumulate dust during extended periods of non-use, which will be emitted when the unit is turned on. This can be mitigated by covering the unit during long periods of inactivity. |
| The unit emits a bad odor | The unit may absorb odors from the environment (such as furniture, cooking, cigarettes, etc.) which will be emitted during operations. |
| | The unit's filters have become moldy and should be cleaned. |
| The fan of the outdoor unit does not operate | During operation, the fan speed is controlled to optimize product operation. |

NOTE: If problem persists, contact a local dealer or your nearest customer service center. Provide them with a detailed description of the unit malfunction as well as your model number.

Troubleshooting

When troubles occur, please check the following points before contacting a repair company.









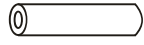
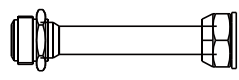
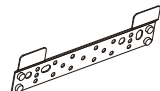
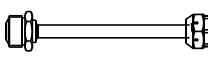

| Problem | Possible Causes | Solution |
|---------------------------------|---|---|
| Poor Cooling Performance | Temperature setting may be higher than ambient room temperature | Lower the temperature setting |
| | The heat exchanger on the indoor or outdoor unit is dirty | Clean the affected heat exchanger |
| | The air filter is dirty | Remove the filter and clean it according to instructions |
| | The air inlet or outlet of either unit is blocked | Turn the unit off, remove the obstruction and turn it back on |
| | Doors and windows are open | Make sure that all doors and windows are closed while operating the unit |
| | Excessive heat is generated by sunlight | Close windows and curtains during periods of high heat or bright sunshine |
| | Too many sources of heat in the room (people, computers, electronics, etc.) | Reduce amount of heat sources |
| | Low refrigerant due to leak or long-term use | Check for leaks, re-seal if necessary and top off refrigerant |

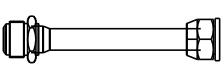
| Problem | Possible Causes | Solution |
|--|---|--|
| The unit is not working | Power failure | Wait for the power to be restored |
| | The power is turned off | Turn on the power |
| | The fuse is burned out | Replace the fuse |
| | Remote control batteries are dead | Replace batteries |
| | The Unit's 3-minute protection has been activated | Wait three minutes after restarting the unit |
| | Timer is activated | Turn timer off |
| The unit starts and stops frequently | There's too much or too little refrigerant in the system | Check for leaks and recharge the system with refrigerant. |
| | Incompressible gas or moisture has entered the system. | Evacuate and recharge the system with refrigerant |
| | System circuit is blocked | Determine which circuit is blocked and replace the malfunctioning piece of equipment |
| | The compressor is broken | Replace the compressor |
| | The voltage is too high or too low | Install a manostat to regulate the voltage |
| Poor heating performance | The outdoor temperature is extremely low | Use auxiliary heating device |
| | Cold air is entering through doors and windows | Make sure that all doors and windows are closed during use |
| | Low refrigerant due to leak or long-term use | Check for leaks, re-seal if necessary and top off refrigerant |
| Indicator lamps continue flashing | <p>The unit may stop operation or continue to run safely. If the indicator lamps continue to flash or error codes appear, wait for about 10 minutes. The problem may resolve itself.</p> <p>If not, disconnect the power, then connect it again. Turn the unit on.</p> <p>If the problem persists, disconnect the power and contact your nearest customer service center.</p> | |
| <p>Error code appears and begins with the letters as the following in the window display of indoor unit:</p> <ul style="list-style-type: none"> • E(x), P(x), F(x) • EH(xx), EL(xx), EC(xx) • PH(xx), PL(xx), PC(xx) | | |

NOTE: If your problem persists after performing the checks and diagnostics above, turn off your unit immediately and contact an authorized service center.

Accessories

The air conditioning system comes with the following accessories. Use all of the installation parts and accessories to install the air conditioner. Improper installation may result in water leakage, electrical shock and fire, or cause the equipment to fail. The items are not included with the air conditioner must be purchased separately.

| Name of Accessories | Q'ty(pc) | Shape | Name of Accessories | Q'ty(pc) | Shape |
|---|----------|--|--|-------------------------|---|
| Manual | 2~4 |  | Soundproof / insulation sheath (some models) | 2 |  |
| Transfer connector (Φ 12.7-Φ 15.9) (some models) | 1 |  | Mounting plate | 1 |  |
| Transfer connector (Φ 6.35-Φ 9.52) (some models) | 1 |  | Anchor | 6 (depending on models) |  |
| Transfer connector (Φ 9.52-Φ 12.7) (some models) | 1 |  | Mounting plate fixing screw | 6 (depending on models) |  |
| Magnetic ring (wrap the electric wires S1 & S2 (P & Q & E) around the magnetic ring twice) (some models) | 1 |  S1&S2(P&Q&E) | Drain joint (some models) | 1 |  |
| | | | Seal ring (some models) | 1 |  |
| Magnetic ring (Hitch it on the connective cable between indoor unit and outdoor unit after installation.) (some models) | 1 |  | Copper nut | 2 |  |
| | | | Red short connected wire (some models) | 1 |  |

Optional accessories

- There are two types of remote controls: wired and wireless. Select a remote controller based on customer preferences and requirements and install in an appropriate place. Refer to catalogues and technical literature for guidance on selecting a suitable remote controller.

| Name | Shape | Quantity(PC) |
|--|-------------|----------------|
| Connecting pipe assembly | Liquid side | Φ 6.35 (1/4in) |
| | | Φ 9.52 (3/8in) |
| | | Φ 12.7 (1/2in) |
| | Gas side | Φ 9.52 (3/8in) |
| | | Φ 12.7 (1/2in) |
| | | Φ 16 (5/8in) |
| | | Φ 19 (3/4in) |
| | | Φ 22 (7/8in) |
| Parts you must purchase separately. Consult the dealer about the proper pipe size of the unit you purchased. | | |